

7.2 Faraday's Experiments

Faraday took a ring of soft iron. On one side of it, an insulated conducting coil was connected with a battery. On the opposite side, another conducting coil was connected with a galvanometer.



Faraday observed that passing a steady current through the left coil produced no effect on the galvanometer in the right coil. However, a momentary deflection of galvanometer was noticed whenever the battery was switched on or off.

When a steady current is passed magnetic flux produced in the left coil passes through the right coil which does not produce any current in it. Whenever the battery is switched on or off, magnetic flux in the right coil changes from zero to maximum or maximum to zero respectively. This rate of change of magnetic flux in the right coil produces current in it.

In another experiment, Faraday arranged two bar magnets in the shape of V. At the open end of V, he kept one soft iron rod with an insulated copper wire wound around it to which galvanometer was connected.

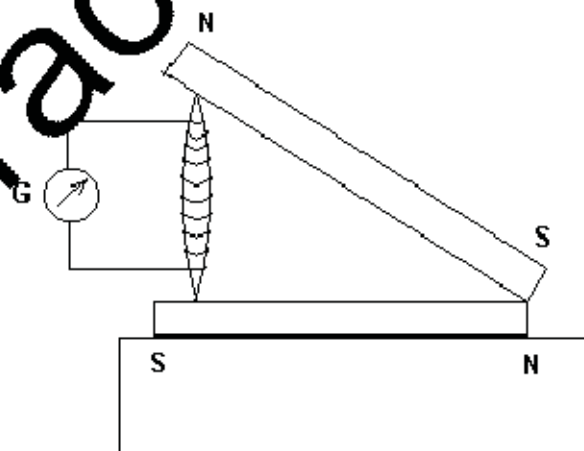

On moving the upper magnet up and down, galvanometer showed deflection. Magnetic flux through the coil increased when the magnet touched the iron rod and decreased when it moved away.

Faraday concluded from these experiments that 'To produce electric field in a coil, the change in magnetic flux is important and not the flux itself.'

Faraday also noted that:

(i) More current is produced when the magnet is moved faster due to faster change of magnetic flux linked with the coil.

(ii) When a coil carrying electric current is placed above another coil and relative motion produced between the two coils, galvanometer shows deflection in the other coil.

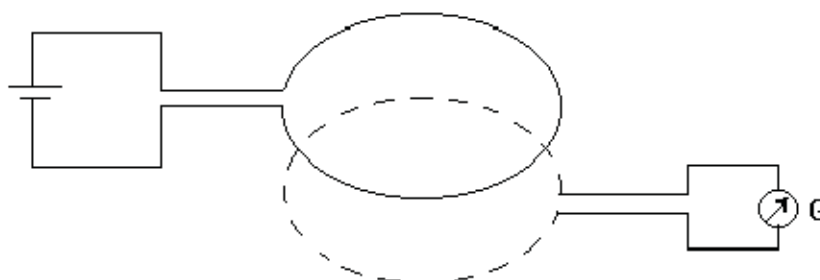

(iii) If any of the two coils is rotated with respect to the other, then also galvanometer shows deflection.

- (iv) If the north pole of a bar magnet is moved towards a coil, the galvanometer shows deflection. Now if the magnet is moved away from the coil, the galvanometer shows deflection in the opposite direction. Similar results are obtained with the south pole of the magnet with deflections of galvanometer in opposite direction.

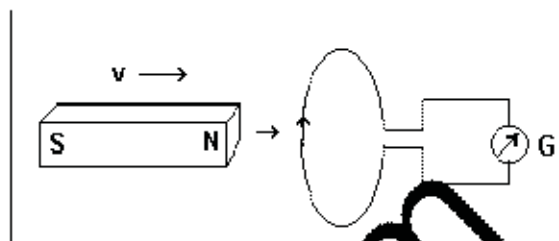

Faraday named the current produced as the 'induced current', the eif as 'induced eif' and the phenomenon as 'magnetic induction'.

7.3 Lenz's Law

As shown in the above figure, suppose a bar magnet is moved towards a conducting coil with its north pole facing the coil. If this produces current in the coil in the clockwise direction as seen from the side of the magnet, then the side of the coil facing the magnet will act like south pole of a magnet and will attract the magnet. The magnet will have accelerated motion towards the coil which will increase the rate of change of flux and hence the current in the coil. This will increase the force of attraction and the acceleration of the magnet will increase further. Thus the current in the coil will go on increasing. If a resistance R is connected in the coil, joule heat I^2Rt is produced in it. No mechanical work is done in giving a slight push to the magnet. Thus heat energy is being continuously produced without spending energy. This is contrary to the law of conservation of energy. Thus our assumption about the direction of current induced in the coil being clockwise is incorrect.

If the direction of induced current were counter-clockwise, the end of the coil facing the north pole of the magnet would have become north pole and mechanical work will be required to be done against the force of repulsion which gets converted in the joule heat in the resistance of the coil. This is consistent with the law of conservation of energy.

Thus "induced emf (or induced current) is produced in such a direction that the magnetic field produced due to it opposes the very cause (here motion of the magnet) that produces it". This statement is known as Lenz's law.

7.4 Faraday's Law

"The induced emf. produced in a closed circuit (or a coil) is equal to the negative of the rate of change of magnetic flux linked with it."

∴ average induced emf. produced,
$$\langle \varepsilon \rangle = - \frac{N \Delta \phi}{\Delta t}$$

and the instantaneous induced emf. at time t ,
$$\varepsilon = - \lim_{\Delta t \rightarrow 0} \frac{N \Delta \phi}{\Delta t} = -N \frac{d\phi}{dt}$$

where, N = number of turns of the coil,

$\Delta \phi$ = change in magnetic flux linked per turn of the coil in time Δt

7.5 Motional emf

The magnetic flux linked with a coil can be changed in many ways. For this,

- (1) the magnet can be moved with respect to the coil.
- (2) the coil can be rotated in the magnetic field.
- (3) the coil can be kept inside the magnetic field in proper manner and the magnitude of the magnetic induction can be changed.
- (4) the coil can be moved inside a non-uniform magnetic field.
- (5) the dimensions of the coil placed inside a magnetic field can somehow be changed.

"The induced emf. produced due to the change in magnetic flux linked with a coil due to some kind of motion is called motional emf."

An example of motional emf. is illustrated as under.

A U-shaped conducting wire is placed in a plane perpendicular to the magnetic field. The magnetic field lines enter the plane of paper as shown by (+) sign.

A conducting rod is slid over the two arms of the conductor with a constant velocity v . The perpendicular distance between the two arms of the conductor is l .

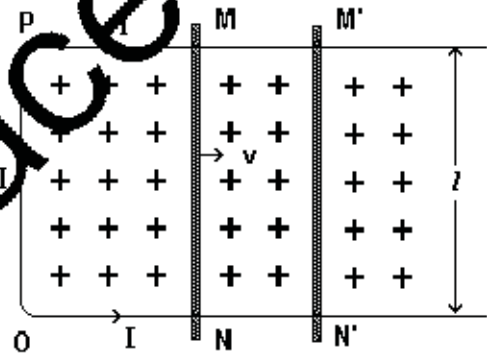

MN is the position of the rod at time t when the magnetic flux linked with the loop PMNO is

$$\phi = (\text{area of PMNO}) \times (\text{magnetic field intensity})$$

$$= l B x, \text{ where } x = PM = N'N$$

According to Faraday's law, the induced emf.,

$$\epsilon = - \frac{d\phi}{dt} = - l B \frac{dx}{dt} = - l B v, \text{ where } v \text{ is the velocity of the sliding rod.}$$

An emf. is generated due to the motion of the rod, it is known as motional emf. Motional emf. is produced by a conducting rod moving in a magnetic field in appropriate manner even without the U-shaped conductor. This is explained in the following example with the reason behind the origin of induced emf.

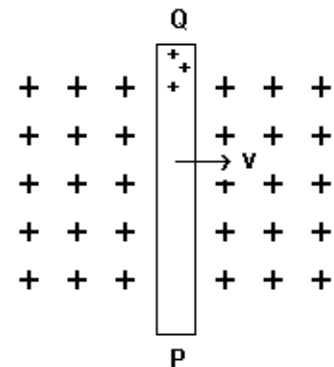

The reason behind the origin of induced emf

With the conducting rod moving with velocity \vec{v} , positive ions and electrons in it also move perpendicularly to the magnetic field \vec{B} . Electrons move from Q to P under the effect of Lorentz force $\vec{F} = q \vec{v} \times \vec{B}$ leaving positive ions exposed at Q. Thus rod behaves as a battery of emf $B v l$.

Conversion of Mechanical Energy into Electrical Energy

In the above example, let I be the current flowing through the sliding conductor. As it is moving in a magnetic field entering the plane of paper, conventional current flows in the rod from P to Q and the rod experiences force IBl in the direction opposite to its velocity v . Thus to maintain its uniform velocity, a force of magnitude IBl must be applied in the direction of its velocity. Such a force is called Lenz force.

Hence, mechanical power, $P_m = \text{force} \times \text{velocity} = Fv = BIlv$
 and electrical power, $P_e = \text{voltage} \times \text{current} = Bvl \times I = BIlv$

Thus, mechanical power spent is converted into electrical power, here ideal case of zero circuit resistance is considered.

7.6 Eddy Currents

Whenever there is a change in magnetic flux associated with conductors of irregular shapes, free electrons in them experience force and move on the path of least resistance.

For example, consider a circular metal plate falling downwards through a uniform magnetic field applied in a direction going into the plane of paper normally as shown in the figure. Here magnetic field is shown only in a limited part, though it is not necessary to be so. Here free electrons inside the plate also move in the downward direction through the magnetic field

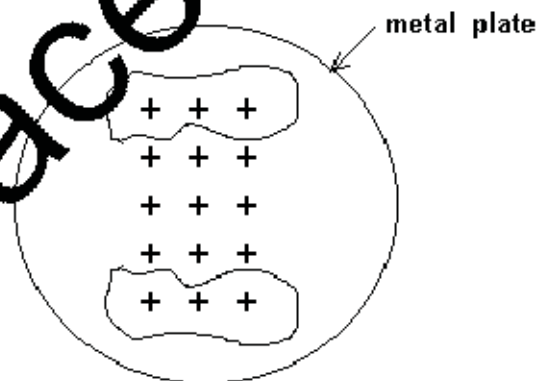

and experience force $\vec{v} \times \vec{B}$. The electrons move on the path that offer minimum resistance and constitute irregular currents called eddy currents. According to Lenz's law, the direction of these currents is such that the magnetic field produced due to them opposes the motion of the conductor and the plate appears to fall with acceleration less than g .

For this reason, when a pendulum made up of metal plate is allowed to oscillate between two poles of a magnet, it performs damped oscillations. Such a damping is called electromagnetic damping.

Eddy currents result in unwanted joule heat. To avoid it, slots are cut in the conductor as shown in the figure which breaks the current loops. Eddy currents can also be reduced by preparing the conductor from insulated laminae of metal.

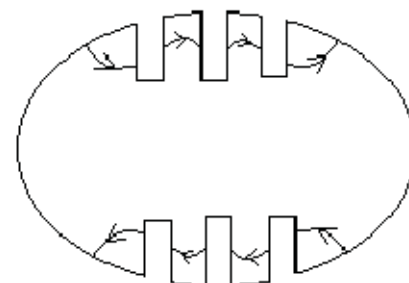

Force acting on a metal rod falling in a magnetic field

is $F = IBL = \frac{BLv}{R} BL$. This force being directly

proportional to v , the eddy currents are used in preparing braking system in trains to apply brakes smoothly.

Eddy currents were first observed by Foucault.

7.7 Self Induction

When electric current is passed through a coil, the magnetic flux produced by the current is linked with the coil itself.

When the current in the coil is changed, the magnetic flux linked with the coil also changes inducing emf in the coil called self induced emf. This phenomenon is called self induction.

The self inductance, L , of the coil is given by

$$L = \frac{N\phi}{I},$$

where N = number of turns in a coil
 ϕ = magnetic flux linked with each turn,
 and I = current through the coil

The self inductance of the coil depends upon

- (i) size and shape of the coil,
- (ii) number of turns of the coil and
- (iii) magnetic property of the medium of the space within the coil.

The self inductance of a coil attains a very large value if the coil is wound around insulated soft iron core.

Differentiating equation $N\phi = LI$ w.r.t. respect to time,

$$N \frac{d\phi}{dt} = L \frac{dI}{dt}$$

Using Faraday's law, the self induced emf is

$$\epsilon = -N \frac{d\phi}{dt} = -L \frac{dI}{dt}$$

When $\frac{dI}{dt} = 1$ unit, $\epsilon = -L$

So the self inductance of the circuit can be defined as under.

"The self induced electromotive force produced per unit rate of change of the current in the circuit is called self inductance of the circuit."

The unit of self inductance is henry (H). If ϵ is in volt, I in ampere and t in second, then L is in henry. Self induced emf is also called 'back emf'.

Circuit symbol of an inductor is as shown in the figure above. The end of the inductor where the current enters is taken as positive and the other end negative. The potential difference between the positive and negative ends of the inductor is given by

$V = L \frac{dI}{dt}$. This p.d. is opposite to the p.d. of the battery providing current.

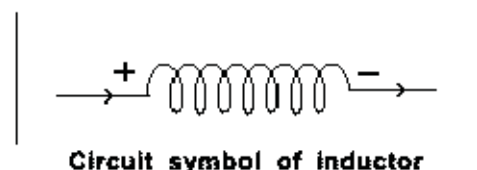
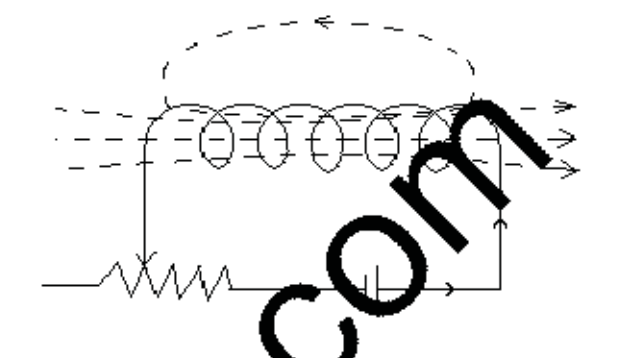

Circuit symbol of inductor

Net power at time t between two ends of the inductor, $V I = L I \frac{dI}{dt}$.

$$\square \quad V I dt = L I (dI)$$

This equation shows that if the current increases by dI in time dt , the electrical energy consumed is $L I (dI)$. Hence to establish a current I in an inductor from time $t = 0$ to time $t = t$, electrical energy consumed is

$$U = \int_0^t V I dt = \int_0^I L I dI = \frac{1}{2} L I^2$$

This energy is linked with the inductor in the form of magnetic field linked with it.

7.8 Mutual Induction

Consider two conducting coils having arbitrary shapes placed near each other with arbitrary inclination with each other as shown in the figure.

Coil 1 has N_1 turns and coil 2 has N_2 turns. When current I_1 flows through coil 1, some of the magnetic field lines generated in it will be linked with coil 2.

According to Biot-Savart law, for given positions of the coils, flux Φ_2 linked with the coil 2 will be proportional to the current I_1 in coil 1.

$$\Phi_2 \propto I_1 \quad \square \quad \Phi_2 = M_{21} I_1 \dots (1)$$

From Faraday's law, the induced emf produced in coil 2 is given by

$$\epsilon_2 = - \frac{d\Phi_2}{dt} = - \frac{d}{dt} (M_{21} I_1) = - M_{21} \frac{dI_1}{dt} \dots (2)$$

It can be proved that $M_{21} = M_{12} = M$. This result is called the reciprocity theorem.

M is termed the mutual inductance of the system formed by the two coils. It can be defined on the basis of equation (1) or (2).

Taking $I_1 = 1$ unit in equation (1), $\Phi_2 = M_{21}$.

Thus, "the magnetic flux linked with one of the coils of a system of two coils per unit current passing through the other coil is called mutual inductance of the system formed by the two coils."

If current is in ampere, flux in Wb, then the unit of mutual inductance is $\text{WbA}^{-1} = \text{henry (H)}$.

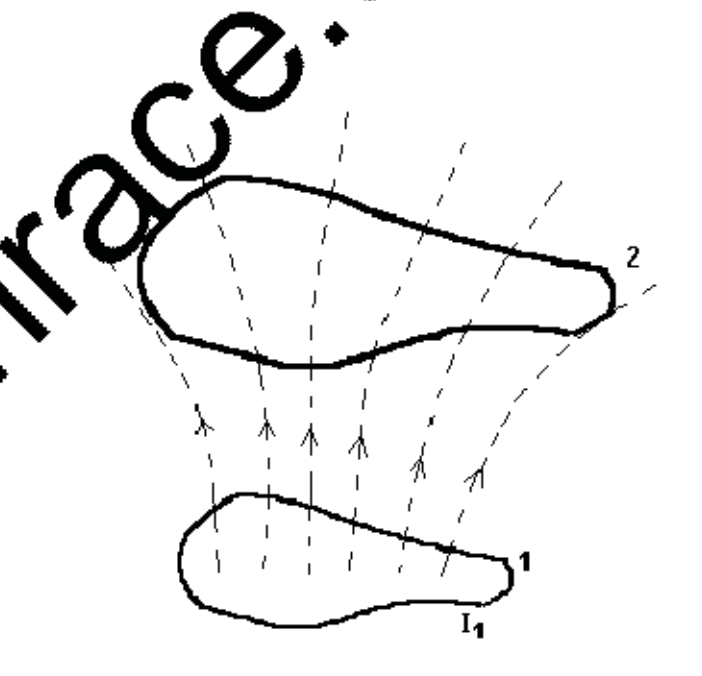

Taking $\frac{dI_1}{dt} = 1$ unit in equation (2), $\mathcal{E}_2 = M_{21}$.

Thus, "the mutual emf generated in one of the two coils due to a unit rate of change of current in the other coil is called mutual inductance of the system of two coils."

If $\frac{dI_1}{dt}$ is in As^{-1} and \mathcal{E}_2 in V, then the unit of mutual inductance is $\text{Vs} / \text{A} = \text{Henry (H)}$.

The value of mutual inductance of a system of two coils depends upon

- (i) shapes and sizes,
- (ii) their number of turns,
- (iii) distance between them,
- (iv) their mutual inclination angle and
- (v) the material on which they are wound.

www.examrace.com